

# Owner's Manual

For all 1999 Bullfrog Portable Spas  
(Multiple Patents Pending)

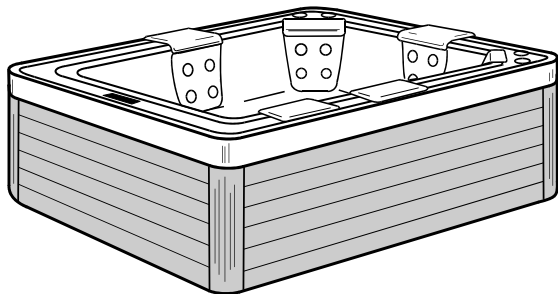

## TABLE OF CONTENTS

### IMPORTANT SAFETY INSTRUCTIONS

U.L. Safety Instructions .....	P. 02
Additional Safety Instructions .....	P. 04

<b>UPGRADES &amp; ACCESSORIES</b> .....	P. 06
---	-------

### INSTALLATION & SET-UP

Selecting a Site for your Spa .....	P. 06
Electrical Requirements & Hook-Up .....	P. 08
Checklist Before Filling Your Spa .....	P. 11
Initial Start-Up .....	P. 12

### OPERATION

Control Systems .....	P. 13
JetPaks .....	P. 23
Jetting .....	P. 24
JetZones .....	P. 25

### MAINTENANCE

Water Chemistry .....	P. 26
Changing Your Spa Water .....	P. 31
Cleaning Your Filter .....	P. 32
Light Bulb Replacement .....	P. 33
Ozone Sterilizer Replacement .....	P. 33
Spa Shell Care .....	P. 34
Spa Cabinet Care .....	P. 34
Spa Cover Care .....	P. 34
Miscellaneous Care .....	P. 35

<b>LOW-USE OR NO-USE PERIODS</b> .....	P. 36
--	-------

<b>SERVICE</b> .....	P. 37
----------------------	-------

<b>TROUBLESHOOTING GUIDE</b> .....	P. 38
------------------------------------	-------

### MISCELLANEOUS

Parts Identification Diagram .....	P. 40
Notes .....	P. 41

# IMPORTANT SAFETY INSTRUCTIONS

When installing and using this electrical equipment, basic safety precautions should always be followed, including the following:

## U.L. SAFETY INSTRUCTIONS:

### 1. READ AND FOLLOW ALL INSTRUCTIONS.

2. **WARNING** - To reduce the risk of injury, do not permit children to use this product unless they are closely supervised at all times.

3. A wire connector is provided on this unit to connect a minimum No. 8 AWG (8.4 mm<sup>2</sup>) solid copper conductor between this unit and any metal equipment, metal enclosures of electrical equipment, metal water pipe, or conduit within 5 feet (1.5 m) of the unit.

#### 4. For 120 Volt Cord-Connected Units:

##### **DANGER - Risk of Injury.**

- a) Replace damaged cord immediately.
- b) Do not bury cord.
- c) Connect to a grounded, grounding type receptacle only.

#### 5. For 120 Volt Units with a GFCI:

**WARNING** - This product is provided with a ground-fault circuit-interrupter (G.F.C.I.) located on the end of the power supply cord. The GFCI must be tested before each use. With the plug connected to the power supply and the unit operating, push the "Test" button on the GFCI. The unit should stop operating and the "Reset" button should pop out. Push the reset button and the unit should start to operate once again. If the unit fails to operate in this manner, there is a ground current flowing indicating the possibility of an electric shock. Disconnect the power unit until the fault has been identified and corrected.

#### 6. **DANGER - Risk of Accidental Drowning.**

Extreme caution must be exercised to prevent unauthorized access by children. To avoid accidents, ensure that children cannot use this spa unless they are supervised at all times.

7. **DANGER - Risk of Injury.** The suction fittings

in this spa are sized to match the specific water flow created by the pump. Should the need arise to replace the suction fittings or the pump, be sure that the flow rates are compatible.

Never operate the spa if the suction fittings are broken or missing. Never replace a suction fitting with one rated less than the flow rate marked on the original suction fitting.

**8. DANGER - Risk of Electric Shock.** Install at least 5 feet (1.5 m) from all metal surfaces. As an alternative, a spa may be installed within 5 feet of metal surfaces if each metal surface is permanently connected by a minimum No. 8 AWG (8.4 mm<sup>2</sup>) solid copper conductor to the wire connector on the terminal box that is provided for this purpose.

**9. DANGER - Risk of Electric Shock.** Do not permit any electric appliance, such as a light, telephone, radio, or television, within 5 feet (1.5 m) of a spa. (These units DO NOT have an integral ground fault circuit interrupter. The installation of a integral ground fault circuit interrupter MUST be done by a qualified Electrician and must meet all local and national codes.)

**10. WARNING - To reduce the risk of injury:**

a) The water in a spa should never exceed 40° C (104°F). Water temperatures between 38°C (100°F) and 40°C are considered safe for a healthy adult. Lower water temperatures are recommended for young children and when spa use exceeds 10 minutes. (Before entering the spa or hot tub measure the temperature with an accurate thermometer.)

b) Since excessive water temperatures have a high potential for causing fetal damage during the early months of pregnancy, pregnant or possibly pregnant women should limit spa water temperatures to 38°C (100°F).

c) Before entering a spa, the user should measure the water temperature with an accurate thermometer since the tolerance of water temperature-regulating devices varies.

d) The use of alcohol, drugs, or medication before or during spa use may lead to unconsciousness with the possibility of drowning.

e) Persons suffering from obesity or with a medical history of heart disease, low or high blood pressure, circulatory system problems, or diabetes should consult a physician before using a spa.

f) Persons using medication should consult a physician before using a spa since some medication may induce drowsiness while other medication may affect heart rate, blood pressure and circulation.

## SAVE THESE INSTRUCTIONS.

### WARNING SIGN

Included with this spa is a warning sign (Fig. A) to inform occasional users and guests of the risk of using the spa. This warning sign is suitable for indoor or outdoor use. Place this warning sign in a conspicuous place adjacent to the spa. For free extra copies call Bullfrog International, L.C. at (801) 565-8111.

### ADDITIONAL SAFETY INSTRUCTIONS:

#### 1. WARNING - Risk of Fatal Hyperthermia.

- a) The use of alcohol, drugs, or medication can greatly increase the risk of fatal Hyperthermia in spas and hot tubs.
- b) The causes, symptoms, and effects of Hyperthermia may be described as follows:

Hyperthermia occurs when the internal temperature of the body reaches a level several degrees above the normal body temperature of 37°C (98.6°F). The symptoms of Hyperthermia include an increase in the internal temperature of the body, dizziness, lethargy, drowsiness, and fainting. The effects of Hyperthermia include:

- Unawareness of impending hazard;
- Failure to perceive heat;
- Failure to recognize the need to exit the spa or hot tub;
- Physical inability to exit the spa or hot tub;
- Fetal damage in pregnant women; and
- Unconsciousness and danger of drowning.

#### 2. WARNING - Risk to Infants, the Elderly, and Women Planning or Experiencing Pregnancy.

Please consult your physician if the above applies to you or anyone using your spa.

#### 3. WARNING - Risk of Children Drowning.

Although your spa cover is not rated as a safety cover, it is wise to always keep the spa cover securely fastened when not in use. This will help discourage children from attempting to enter the spa while not supervised by an adult.

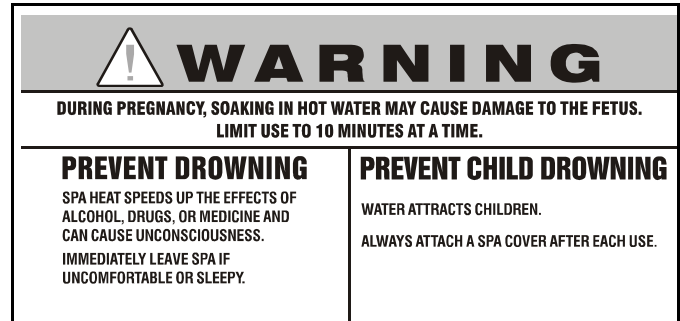

(Figure A) Warning Sign

**4. WARNING - Risk of Drowning.** Use caution when bathing alone. Overexposure to hot water may cause nausea, dizziness, and fainting.

**5. WARNING - Risk of Injury.** Always use extreme caution while entering or exiting the spa. Surfaces can be very slippery when wet. Do not step or sit on HeadRests. Also, keep all breakable objects out of the spa area.

**6. WARNING - Risk of Injury.** Never use the spa immediately after strenuous exercise.

**7. WARNING - Risk of Injury.** Prolonged use of the spa may be injurious to your health.

**8. WARNING - Risk of Injury.** Individuals with infectious diseases should not use the spa.

**9. WARNING - Risk of Injury.** Short term inhalation of high concentrations of ozone and long term inhalations of low concentrations of ozone can cause serious physiological effects. Do not inhale ozone gas produced by your spa's Ozone Sterilizer.

**10. WARNING - Risk of Injury.** Maintain water chemistry in accordance with chemical manufacturer's instructions.

**11. WARNING - Risk of Shock.** Spa shall not be operated in severe weather conditions, i.e. electrical storms, tornadoes, etc.

**12. CAUTION - Unauthorized Access.** Secure the spa area against unauthorized access. Make sure all barriers meet both state and local codes. Keep spa cover on spa when spa is not being used.

**13. CAUTION - Risk of Damage to Spa or Equipment.** By performing maintenance as described later in this Owner's Manual, the chance of damage to your spa and it's equipment will be greatly reduced. Never block the air vents that lead to the spa equipment compartment. Doing so may cause the spa equipment to overheat.

**14. CAUTION - Non-Approved Accessories.** Using accessories not approved by Bullfrog International, L.C. could void your warranty or cause other problems. Please consult with your authorized Bullfrog Portable Spa Dealer.

**15. CAUTION - Location of Your Spa.** Locate your spa on a surface that can withstand the weight bearing requirements of the spa (see "Selecting a Site for your Spa" in this Manual). Also, locate your spa in an environment that can withstand repeated exposure to water and the possibility of a major spill.

## UPGRADING YOUR BULLFROG SPA

The following are possible upgrades for your Bullfrog Spa:

**New JetPak™ designs:** As new jet types and styles become available so will new innovative JetPak modules (Fig. B). Check with your authorized Bullfrog Spa Dealer on a yearly basis to see what's available.

**PowerPlus™:** When you're ready for more horsepower and more jets, just call your authorized Bullfrog Spa Dealer and ask for PowerPlus.

**WellSpring™ Ozone Sterilizer:** For cleaner spa water, we use the most simple, reliable, user-friendly, affordable ozone system on the market. If your spa did not come with one, it's well worth the investment.

**IMPORTANT:** Your spa was designed, tested, and UL Listed with a Bullfrog ZO-310 Ozone Sterilizer. No other Ozone Sterilizer is recommended for your Bullfrog Portable Spa.

**Tablet Feeder - Chlorine/Bromine:** This Tablet Feeder allows you to sanitize your spa water each time your filter pump turns on, saving you from having to do so. Also, your Tablet Feeder is out of sight and yet easy to get to.

**Miscellaneous Upgrades:** For upgrades as they become available, keep in touch with your authorized Bullfrog Spa Dealer.

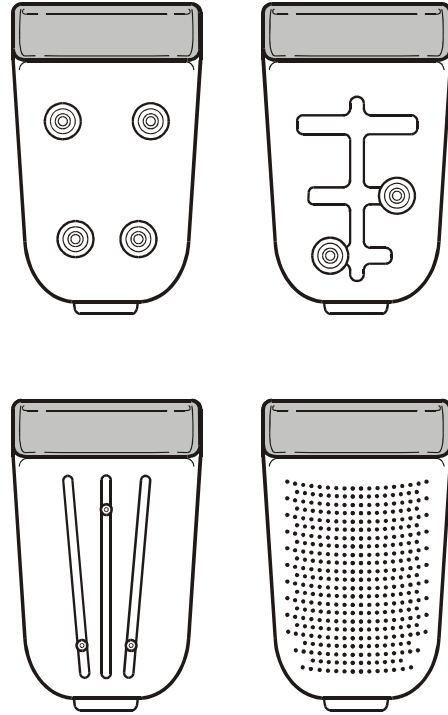

(Figure B) Several JetPak™ Variations

## INSTALLATION & SET-UP

Before attempting to install or use your spa, please read the U.L. Safety Instructions, the Additional Safety Instructions, as well as all of the Installation Instructions that follow:

### SELECTING A SITE FOR YOUR SPA:

Your Bullfrog Spa was designed for either indoor or outdoor use. Whether indoors or outdoors, please adhere to the following guidelines:

1. Select a site that is stable and capable of supporting the weight of your spa, its water, and the people using it (refer to the "Technical Specification Sheet" in this manual for the Filled Weight of your spa). If installed on a suspended floor/deck, the floor/deck should be capable of supporting your spa. If you have concerns on this matter, please contact a qualified Licensed Contractor.
2. Select a surface that is flat and reasonably level. This surface must provide continuous support for the entire bottom of the spa. Do not shim or block up the spa creating voids below the spa.
3. Avoid installing the spa in a pit or low area where water may accumulate and damage the spa or its equipment. Choose a site where water will drain away.

from the spa and not towards it.

4. Important: With all installations, the spa must be located at least 5 feet from all electrical outlets, switches, and other permanently installed electrical devices.

**Indoor Considerations:** There are several considerations when installing your spa indoors: First, the environment both around and below the spa should be water resistant. It must be capable of handling water splashed out from the spa as well as the possibility of a leak from the spa (Your Bullfrog portable spa is the most leak-free spa in the industry, but there is still the possibility of a leak from the spa. A catch basin equivalent to the volume of your spa is recommended); Second, it is recommended that the room you install the spa in has proper ventilation. Proper ventilation can usually be achieved by an exhaust fan or an open window.

*Note: Typical indoor surfaces include, but are not limited to: concrete, wood, non-slip tile, or linoleum.*

**Outdoor Considerations:** When selecting an outdoor site, several things should be considered: First, Avoid selecting a site where excessive water may contact the spa, such as from sprinklers or a roof edge without rain gutters; Second, and if possible, avoid areas of direct, prolonged sunlight. The ultraviolet rays of sunlight will tend to fade and damage your spa cover and cabinet; Third, Check your local codes on possible restrictions that require fencing or childproof gates around your spa; Last, avoid locating your spa in an area where debris will be tracked into the spa.

*Note: Typical outdoor surfaces include, but are not limited to: concrete, brick, non-slip tile, wood-decking, peagravel or sand.*

# ELECTRICAL REQUIREMENTS & HOOK-UP

All Bullfrog Portable Spas must be wired in accordance with all local & national electric codes. Have a licensed electrician perform the electrical installation.

**Important:** All metal enclosures, pipe or conduit located within 5 feet (1.5m) of the spa must be bonded to the Control Center Box located inside the equipment compartment of the spa. The wire used to complete this bonding must be a minimum No. 8 (8.4mm<sup>2</sup>) solid copper wire. It is to be connected to the ground lug connector on the exterior surface of the Control Center Box and all metal items described above.

## WIRING DIAGRAMS

Please reference the wiring diagram that is specific to your spa's Control System:

- Economy Control System /BULF30 (Fig. C)
- Deluxe Control System/BULF50 (Fig. D)
- Premium Control System/BULF60 (Fig. E)

## 120V/240V CONVERTIBLE EQUIPMENT

Unless you special ordered 120 Volt equipment, your Bullfrog Portable Spa comes standard as a 240 Volt spa.

If your spa is equipped with an Economy Control System (BULF30), it can be wired as either a dedicated 120V or 240V system.

With the Economy Control System, you can take advantage of the Bullfrog PowerPlus feature by upgrading your 120V system to a more powerful 240V system. The 240V system allows you to increase horsepower as well as heating capacity.

For specific conversion instructions, please refer to the system wiring diagram locating inside of the control system box.

## 120 VOLT INSTALLATION

Use only a qualified Licensed Electrician to make 120 Volt electrical installations.

Your 120 Volt spa requires a dedicated GFCI 20 AMP electrical circuit and a minimum supply wire size of 12 gauge. It is important that this circuit is dedicated (not being used by any other electrical appliance) or your spa may not function properly.

Position your Bullfrog Portable Spa at least 5 feet (1.5m) from all electrical outlets or devices.

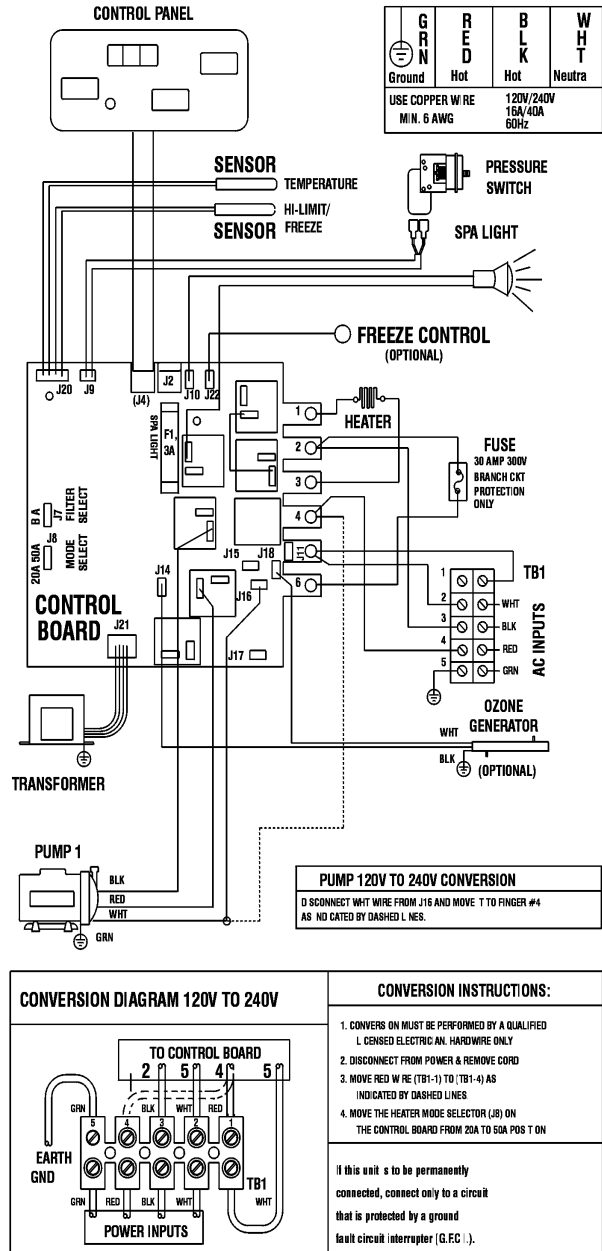

(Figure C) Economy 120V/240V Wiring



## 240 VOLT INSTALLATION

Use only a qualified Licensed Electrician to make 240 Volt electrical installations.

Your 240 Volt Bullfrog Portable Spa requires a dedicated 50 AMP electrical circuit and a minimum supply wire size of 6 gauge. It is important that this circuit is dedicated (not being used by any other electrical appliance) or your spa may not function properly.

Position your Bullfrog Portable Spa at least 5 feet (1.5m) from all electrical outlets or devices.

**30 AMP Conversion Option:** If you do not have 50 AMPS of electrical service available, your authorized Bullfrog Portable Spa Dealer or electrician can easily convert your spa to operate on 30 AMPS with a minimum supply wire size of 10 gauge. Please be aware, that spas converted to 30 AMPS are only capable of heating the water when the circulation pump is in low-speed, not high-speed. This heating limitation is acceptable in most climates as well as in indoor installations.

### ELECTRICIAN'S INSTRUCTIONS:

**NOTICE:** As of January 1, 1994, the National Electric Code (Article 680-42) requires that all spas, hot tubs, and associated electrical components shall be protected by Ground Fault Circuit Interrupters.

**Providing 120 Volt Service to the Bullfrog Portable Spa:** As per code, supply a GFCI protected, 3-wire (Line 1, Neutral & Ground), 20-AMP, 60HZ, Single-Phase service to the back, left corner (when you are facing the control pad) of the Bullfrog Portable Spa. This service must include a disconnect that is visible from the spa and located not less than five feet from the spa and not more than 50 feet from the spa (a GFCI Sub-Panel may be used to substitute the disconnect if located within the same parameters).

**Providing 240 Volt Service to the Bullfrog Portable Spa:** As per code, supply a GFCI protected, 4-wire (Line 1, Line 2, Neutral & Ground), 50-AMP, 60HZ, Single-Phase service to the back, left corner (when you are facing the control pad) of the Bullfrog Portable Spa. This service must include a disconnect that is visible from the spa and located not less than five feet from the spa and not more than 50 feet from the spa (a GFCI Sub-Panel may be used to substitute the disconnect if located within the same parameters).

**Installation of the GFCI:** All conductors except the green ground must be routed through the GFCI, including the neutral. Never bypass the neutral line. If the neutral line is bypassed, then the current will be imbalanced and cause the GFCI to trip.

**Note:** For a GFCI wiring diagram, please contact Bullfrog International, L.C. or an authorized Bullfrog Portable Spa Dealer.

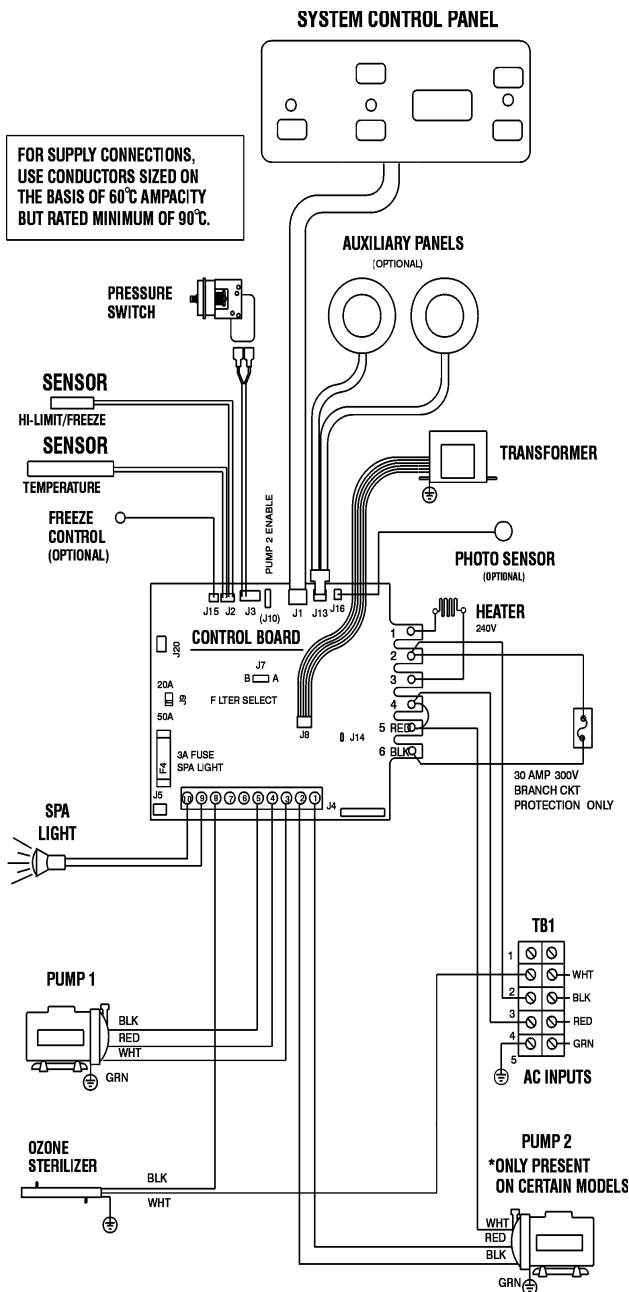

(Figure D) Deluxe 240V Wiring Diagram

## Connecting the Spa:

1. Remove the equipment compartment door.
2. Remove the face-plate to the Control Center by removing the four screws located in the front.
3. Connect a 1" non-metallic coupling and conduit to the 1" male CPVC pipe found at the base of the spa cabinet (see "Parts Identification Diagram" in this manual).
4. Run the required wires through the conduit and to the Control Center.
5. Connect the 3 wires (120V systems)/4 wires (240V systems) to the terminal block located in the Control Center (see appropriate "Wiring Diagram").
6. Replace the Control Center face-plate and the equipment compartment door.
7. The electrical hook-up is complete.

**Important:** Do not fill or start-up the spa until you have completed the following section.

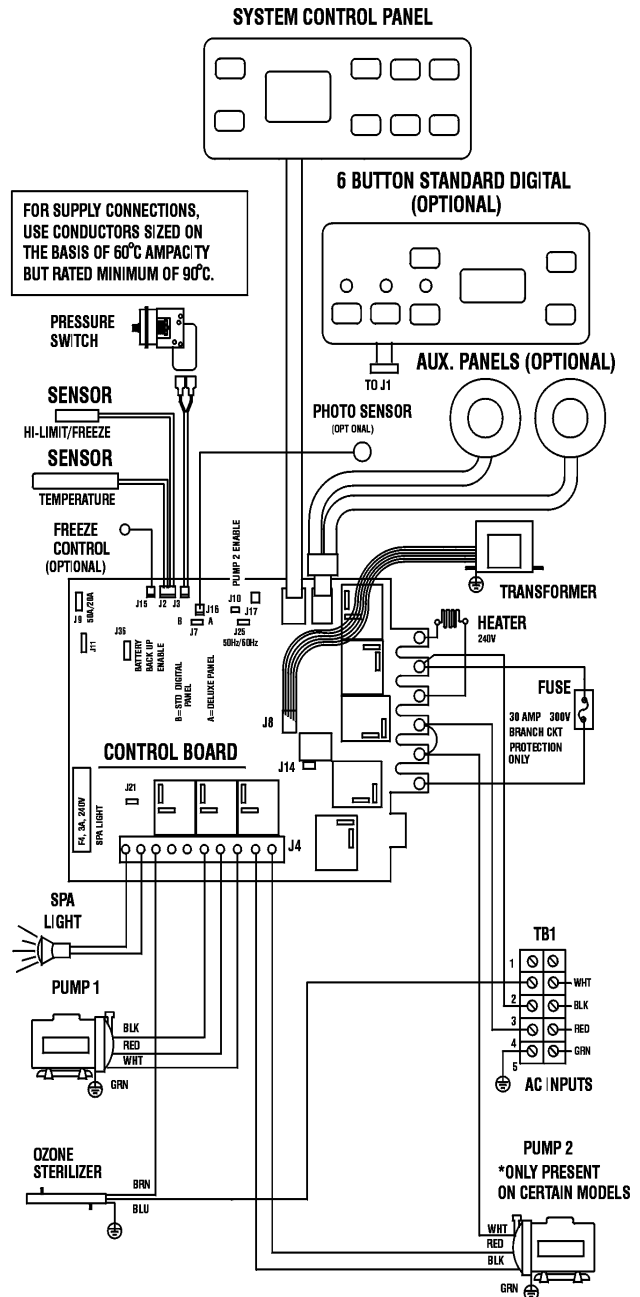

(Figure E) Premium 240V Wiring Diagram



(Figure F) Drain Cap

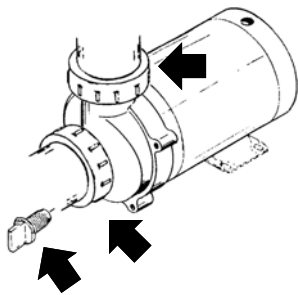

(Figure G) Spa Fittings

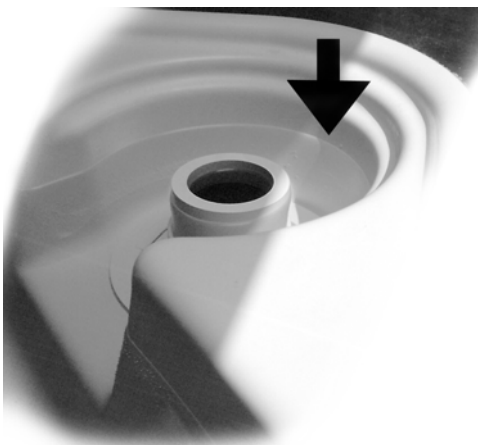

(Figure H) Fill Level Indication Marks

## CHECKLIST BEFORE FILLING YOUR SPA

**Important:** The equipment should never be operated without water in the spa. Serious damage to the pump and/or heater may occur.

❑ **1. Installing Your Cover:** Your spa cover comes with tie-down straps and locking hardware to attach the cover to the spa or decking. If your Dealer did not install your cover, then refer to Cover Installation Instructions that come in the cover cardboard packaging.

❑ **2. Check Drain-Cap:** At the end of the drain hose (located in the Equipment Compartment) is the Drain-Cap (Fig. F) Make sure it is securely fastened to the end of the drain hose.

❑ **3. Tighten Equipment Fittings:** In the equipment compartment, hand-tighten all PVC Pipe Unions and Pump Drain Plugs (Fig. G) to prevent the possibility of leakage (sometimes these fittings loosen during shipment).

❑ **4. Fill the Spa:** Fill the spa to any point between the two Water Level Indentation marks (Fig. H) on the back wall of the filter/skimmer cavity.

*Note 1: The higher the water level, the less spa users it will take to cause the water to overflow the top of the spa.*

*Note 2: Do not fill the spa with soft water unless the mineral content is raised immediately (see your Dealer).*

❑ **5. Check for Leaks:** After the spa is full, but before turning the power on, check all the fittings and equipment in the equipment compartment for signs of leakage. If a leak is detected, except from fittings that can be hand-tightened, call your authorized Bullfrog Spa Dealer.

## INITIAL START-UP

**Important:** Bullfrog Spas come with either an *Economy*, *Deluxe* or *Premium* Control System. Refer only to the Control System that applies to your spa.

### ECONOMY CONTROL SYSTEM:

Turn on the circuit breaker. Your spa will start up automatically and will heat to 100°F (38°C) if no other temperature is set. Depending on the outside ambient temperature, your spa will heat at the rate of .5-1° per hour for 120 Volt systems and between 5-10° per hour for 240 Volt systems.

One minute after start-up, the spa will begin a 4-hour filter cycle to clean the water. To select a different duration, see "Preset Filter cycles" under "Operation".

### DELUXE CONTROL SYSTEM:

Turn on the circuit breaker. Your spa will start up automatically and will heat to 100°F (38°C) if no other temperature is set. When your spa is first actuated it will start up in the Economy Mode and the LCD will alternately flash "Econ", the current spa temperature, and "COOL" until the spa water is less than 15°F cooler than the set temperature. During each filter cycle, the spa will heat to the set temperature. Depending on the outside ambient temperature, your 240 Volt spa will heat at the rate of 5-10° per hour.

One minute after start-up, the spa will begin a four hour filter cycle to clean the water. To select a different duration, see "Preset Filter cycles" under "Operation".

### PREMIUM CONTROL SYSTEM:

Turn on the circuit breaker. Your spa will start up automatically and will be in the Economy Mode. Simply press the "#" button to switch the spa to the Standard Mode and begin heating. The spa will heat to 100°F (38°C) if no other temperature is set. Depending on the outside ambient temperature, your 240 Volt spa will heat at the rate of 5-10° per hour.

**Time of Day:** You will see the words "set time" flashing on the display. To set the time, press the "Time" button then the "\*" button then the "Warmer" or "Cooler" button. After either button is pressed once, the time will begin changing in one-minute increments. Press either button to stop the time from changing. Press the "#" button to enter your correct time into the system.

Now that the time has been set correctly, your spa will automatically filter itself for a 2-hour period every 12 hours. For average use, a 4-hour filter cycle is recommended. To select a different duration, see "Filter Cycles" under "Operation".

**Note:** *If the spa does not activate after turning on the circuit breaker, it may be necessary to press the "Reset Button" on the GFCI breaker.*

## OPERATION

**Important:** Bullfrog Spas come with either an *Economy*, *Deluxe* or *Premium* Control System. Please refer only to the Control System that applies to your spa.

### ECONOMY CONTROL SYSTEM

#### MASTER CONTROL PAD (Fig. 1)

##### Temperature Adjustment (80°F - 104°F)

Temperature adjustment is controlled by pushing the "Temp Set" button. The display shows the actual water temperature unless the button is pressed. When the button is pressed, the display will show the set temperature. Pressing the button a second time will cause the set temperature to increase or decrease depending on what direction was last chosen. Each successive press will change the set temperature in the same direction.

If the opposite direction is desired, release the button and let the display revert to the actual water temperature again. Press the button to display the set temperature, and again to make the temperature change in the desired direction.

##### Jets

Press the "Jets" button to operate the pump. Press the button once to turn on the low-speed pump. Press the button again to turn on the high-speed pump, and again to turn off the pump. The low-speed pump will automatically turn off after 2 hours and the high-speed pump after 30 minutes. Due to Automatic Spa Control, the low-speed pump will start automatically when the heater is turned on, when a filter cycle is activated, or when a freeze condition is detected. If the low-speed pump is on under the Automatic Spa Control, it can only be deactivated by entering the Standby Mode.

##### Light

Press the "Light" button to turn the spa light on and off. The spa light will turn itself off after 4 hours of operation.

##### Standard and Economy Mode

The Standard Mode is the default operation mode for the spa. When in Standard mode, the spa maintains the desired temperature at all times. In Economy mode, the spa only heats water during filter cycles and has a fixed temperature setting of 100°F. To activate the Economy Mode, change the temperature setting on the Master Control Pad down to 80°F by pressing the "Temp Set" button. Press the button again and your spa will enter into the Economy Mode.

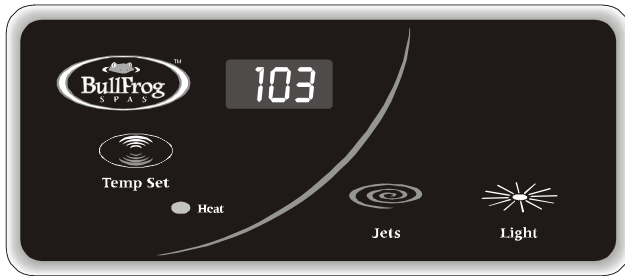

(Figure 1) Economy Control Pad

## Standby Mode

(Use when removing JetPaks or cleaning the filter)

Press the "Temp Set" temperature button and then the "Light" button. The display will show "Sb" and all functions will be disabled except for freeze control. Press any button to reset the system.

**Preset Filter Cycles:** Your spa will automatically filter itself twice each day. The first filter cycle will begin one minute after the spa is energized. The second filter cycle will begin twelve hours after the start of the first filter cycle. Filtration duration is programmable at the Master Control Pad. Press the "Temp Set" button, then the "Jets" button, and "F4" will be displayed on the panel. F4 is the default filter time and indicates a 4 hour cycle. Continue pressing the "Temp Set" button to cycle through the rest of the filter time options; "F2" = 2 hours, "F4" = 4 hours, and "F6" = 6 hours. Press the "Jets 1" button to exit filter programming. During filtration, the low-speed pump and ozone sterilizer (if installed) will run.

**Ozone Sterilizer (optional):** For safety purposes, your Ozone Sterilizer is disabled for a 30 minute period whenever a "Jets" button is pressed.

## SAFETY/FEATURE MESSAGES:

**Overheat Protection** (Spa is Deactivated.)

**DO NOT ENTER THE WATER.** If a malfunction occurs and the spa water has reached 112°F, the display will flash "OH" (meaning over-heat) and the system will completely shut down. Remove the cover to cool the water. Overheating may also occur if the filter duration is set too long. At 110°F, the spa should reset itself. If the high-limit sensor detects 118°F at the heater, the spa will shut down. When the heater cools to 110°F, press any button to reset the spa. If the spa will not reset, then shut off power to the spa and contact your authorized Bullfrog Spa Dealer.

## Flow Switch Detection

If the panel display is flashing "FL" (meaning flow) alternately with Temperature, one of the following may have occurred:

- 1- The filter may be plugged. Remove the filter and clean.
- 2- The amount of water flow may be inadequate. Make sure the spa is filled correctly.
- 3- A pressure switch may have malfunctioned. The spa will continue to operate, but the heater will not activate. Contact your authorized Bullfrog Spa Dealer.

**Open Sensor** (Spa is deactivated)

If the Control Pad display shows “Sn” (meaning sensor), then either the high-limit or water temperature sensor has malfunctioned. This must be repaired only by an authorized Bullfrog Portable Spa Dealer.

#### **Standby Mode (Spa is deactivated.)**

When “Sb” appears on the panel display, all spa functions have been disabled except for freeze control. Press any button on the control pad to reset the system. The “Standby Mode” is primarily used to prevent the pumps from being activated while changing JetPaks, cleaning the filter or cleaning the skimmer basket.

**Warning! Shock Hazard! No User Serviceable Parts.** Do not attempt service of this control. Contact your authorized Bullfrog Spa Dealer. Follow all Owner’s Manual power connection instructions. Installation must be performed by a licensed electrician, and all grounding connections must be properly installed.

## **DELUXE CONTROL SYSTEM**

### **MASTER CONTROL PAD (Fig. J:)**

#### **Temperature Adjustment (80°F - 104°F)**

The current temperature is constantly displayed on the LCD. Press either the “Warmer” or “Cooler” button once to display the set temperature. (The set temperature is designated by a triangle in the upper left corner.) Each time either button is pressed again, the set temperature will increase or decrease depending upon which button is pressed. After three seconds, the LCD will automatically display the current spa temperature.

#### **Jets 1**

Press the “Jets 1” button to operate pump 1. Press the button once to turn on the low-speed pump. Press the button again to turn on the high-speed pump, and again to turn off the pump. The low-speed pump will automatically turn off after 2 hours and the high-speed pump after 30 minutes. Due to Automatic Spa Control, the low-speed pump will start automatically when the heater is turned on, when a filter cycle is activated, or when a freeze condition is detected. If the low-speed pump is on under the Automatic Spa Control, it can only be deactivated by entering the Standby Mode.

#### **Jets 2**

Press the “Jets 2” button to operate pump 2 (if installed). Press the button once to turn on the low-speed pump. Press the button again to turn on the high-speed pump, and again to turn off the pump. The low-speed pump & the high-speed pump will

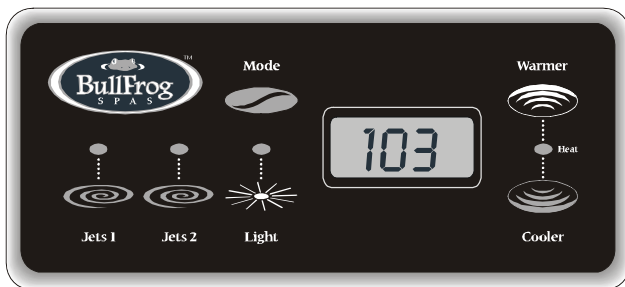

**(Figure J) Deluxe Control Pad**

automatically turn off in 30 minutes.

## Light

The spa light has 3 settings. Pressing the "Light" button changes the intensity from the brightest setting to the dimmest setting, then turns it off. The spa light will turn itself off after 4 hours of operation.

## Standard and Economy Mode

Press the "Mode" button to switch between Economy and Standard modes. When in Economy mode, the spa only heats water during filter cycles. In Standard mode, the spa maintains the desired temperature at all times.

## Standby Mode

(Use when removing JetPaks or cleaning the filter)

Press either the "Warmer" or "Cooler" button and then the "Light" button. The display will show "Stby" and all functions will be disabled except for freeze control. Press any button to reset the system.

## Auxiliary Control Pads - Optional (See Fig. K)

**Pump 1:** Press the "Jets 1" button to operate pump 1. Press the button once to turn on the low-speed pump. Press the button again to turn on the high-speed pump, and again to turn off the pump. The low-speed pump will automatically turn off after 2 hours and the high-speed pump after 30 minutes.

**Pump 2:** Press the "Jets 2" button to operate pump 2 (if installed). Press the button once to turn on the low-speed pump. Press the button again to turn on the high-speed pump, and again to turn off the pump. The low-speed pump and the high-speed pump will automatically turn off after 30 minutes.

**Preset Filter Cycles:** Your spa will automatically filter itself twice each day. The first filter cycle will begin one minute after the spa is energized. The second filter cycle will begin twelve hours after the start of the first filter cycle. Filtration duration is programmable at the Master Control Pad. Press the "Warm" or "Cool" button, then the "Mode" button, and "FIL4" will be displayed on the panel. FIL4 is the default filter time and indicates a 4 hour cycle. To increase or decrease the filter times, press the "Warm" or "Cool" button respectively. "FIL2" = 2 hours, "FIL4" = 4 hours, and "FIL6" = 6 hours. Press the "Mode" button to exit filter programming. During filtration, the low-speed pump and ozone sterilizer (if installed) will run. The low speed of pump 2 purges for 5 minutes at the beginning of each filter cycle.

**Ozone Sterilizer (optional):** For safety purposes, your Ozone Sterilizer is disabled for a 30 minute period whenever a "jets" button is pressed.

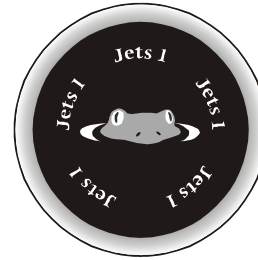

(Figure K) Auxiliary Control Pad



## SAFETY/FEATURE MESSAGES:

### Economy Mode

The spa is in economy mode. "Econ" is flashed alternately with the current temperature and "COOL" until the spa water is less than 15°F cooler than the set temperature.

### Overheat Protection (Spa is Deactivated.)

**DO NOT ENTER THE WATER.** If a malfunction occurs and the spa water has reached 112°F, the display will flash "OH" (meaning over-heat) and the system will completely shut down. Remove the cover to cool the water. Overheating may also occur if the filter duration is set too long. At 110°F, the spa should reset itself. If the high-limit sensor detects 118°F at the heater, the spa will shut down. When the heater cools to 110°F, press any button to reset the spa. If the spa will not reset, then shut off power to the spa and contact your authorized Bullfrog Spa Dealer.

### Flow Switch Detection

If the panel display is flashing "FLO" (meaning flow) alternately with Temperature, one of the following may have occurred:

- 1- The filter may be plugged. Remove the filter and clean.
- 2- The amount of water flow may be inadequate. Make sure the spa is filled correctly.
- 3- A pressure switch may have malfunctioned. The spa will continue to operate, but the heater will not activate. Contact your authorized Bullfrog Spa Dealer.

### Flow Switch Failure

If the panel display shows a constant "FLO", a pressure switch has malfunctioned. Contact your authorized Bullfrog Spa Dealer.

### Temperature Set Back

When the display shows "COOL", the spa water is more than 20°F cooler than the set temperature. The heater will automatically activate to provide freeze protection. This is a normal spa function; no corrective action is necessary.

### Freeze Protection

If a freeze condition is detected "ICE" will be displayed on the panel. The pump(s) will be automatically activated. This is a normal spa function; no corrective action is necessary. Freeze protection is enabled regardless of the spa's status.

### High-Limit Sensor Failure (Spa is deactivated.)

When the panel display shows “**Sn1**” the high-limit temperature sensor is non-functional. This must be repaired only by an authorized Bullfrog Spa Dealer.

### Main Sensor Failure (Spa is deactivated.)

If “**Sn3**” appears on the display, the main sensor is non-functional. This must be repaired only by an authorized Bullfrog Spa Dealer.

### Standby Mode (Spa is deactivated.)

When “**Stby**” appears on the panel display, all spa functions have been disabled except for freeze control. Press any button on the control pad to reset the system. The “Standby Mode” is primarily used to prevent the pumps from being activated while changing JetPaks, cleaning the filter or cleaning the skimmer basket.

### Warning! Shock Hazard! No User Serviceable Parts.

Do not attempt service of this control. Contact your authorized Bullfrog Spa Dealer. Follow all Owner’s Manual power connection instructions. Installation must be performed by a licensed electrician, and all grounding connections must be properly installed.

## PREMIUM CONTROL SYSTEM

### MASTER CONTROL PAD (Fig. L)

#### Liquid Crystal Display

This feature constantly displays the spa temperature, as well as the various monitoring functions.

#### Program Buttons

The “\*” button initiates time setting, filter programming, and panel lock routines.

The “#” button is used to switch between Economy and Standard operation modes and also serves as an “enter” button to initiate various programming features.

#### Time

Press the “Time” button to view the time of day. Press again to view the temperature of the spa water. To change the time of day, see “Time of Day” in the “Initial Startup” section of this Owner’s Manual.

#### Temperature Adjustment (80°F - 104°F)

The current temperature is constantly displayed on the LCD. Press either the “Warmer” or “Cooler” button once to display the set temperature and the



(Figure L) Premium Control Pad

words "set heat". Each time either of these buttons is pressed again, the set temperature will increase or decrease depending upon which button is pressed. After three seconds, the LCD will automatically display the current spa temperature.

### **Jets 1**

Press the "Jets 1" button to operate pump 1. Press the button once to turn on the low-speed pump. Press the button again to turn on the high-speed pump, and again to turn off the pump. The low-speed pump will automatically turn off after 2 hours and the high-speed pump after 30 minutes. Due to Automatic Spa Control, the low-speed pump will start automatically when the heater is turned on, when a filter cycle is activated, or when a freeze condition is detected. If the low-speed pump is on under the Automatic Spa Control, it can only be deactivated by entering the Standby Mode.

### **Jets 2**

Press the "Jets 2" button to operate pump 2 (if installed). Press the button once to turn on the low-speed pump. Press the button again to turn on the high-speed pump, and again to turn off the pump. The low-speed pump & the high-speed pump will automatically turn off in 30 minutes.

### **Light**

The spa light has 3 settings. Pressing the "Light" button changes the intensity from the brightest setting to the dimmest setting, then turns it off. The spa light will turn itself off after 4 hours of operation.

### **Standard and Economy Mode**

Press the "#" button to switch between Economy and Standard modes. When in Economy mode, the spa only heats water during filter cycles. In Standard mode, the spa maintains the desired temperature at all times.

### **Standby Mode**

(Use when removing JetPaks or cleaning the filter)

Press either the "Warmer" or "Cooler" button and then the "Light" button. The display will show "Stby" and all functions will be disabled except for freeze control. Press any button to reset the system.

### **Locking the Control Pad**

To lock the entire control pad, press the "\*" button then the "#" button then the "Warmer" button all within 3 seconds. When locked, the display will show the spa temperature along with the lock symbol. All buttons will be frozen except the "\*" button which is used to initiate the unlock sequence.

### Locking the Temperature Only

To lock the temperature, press either the “Warmer” or “Cooler” button to initiate the “set heat” mode. Next, and within a 3 second time span, press the “\*” button then the “#” button then the “Warmer” button. When locked, the display will show the spa temperature, the “set heat” statement, and the lock symbol. All buttons will be frozen except the “\*” button which is used to initiate the unlock sequence.

### Unlocking the Control Pad

By pressing the “\*” button then the “#” button then the “Cooler” button within 2 seconds, the lock symbol will disappear and the control pad buttons will work again.

### Auxiliary Control Pads - Optional (See Fig. M)

**Pump 1:** Press the "Jets 1" button to operate pump 1. Press the button once to turn on the low-speed pump. Press the button again to turn on the high-speed pump, and again to turn off the pump. The low-speed pump will automatically turn off after 2 hours and the high-speed pump after 30 minutes.

**Pump 2:** Press the "Jets 2" button to operate pump 2 (if installed). Press the button once to turn on the low-speed pump. Press the button again to turn on the high-speed pump, and again to turn off the pump. The low-speed pump and the high-speed pump will automatically turn off after 30 minutes.

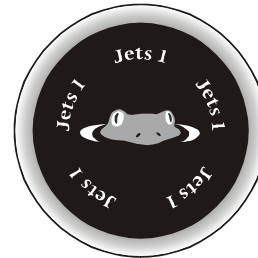

(Figure M) Auxiliary Control Pad

### FILTER CYCLES:

**Preset Filter Cycles:** Your spa will automatically filter itself for a 2-hour period every 12 hours. The first filter cycle will begin at 2:00 AM and will continue until 4:00 AM. The second filter cycle will begin at 2:00 PM and will continue until 4:00 PM. When a filter cycle is active, it will be indicated on the display with a message stating “Filter 1” for the first (AM) cycle or “Filter 2” for the second (PM) cycle. During filtration, the low-speed pump and ozone sterilizer (if installed) will run. The low speed of pump 2 purges for 5 minutes at the beginning of each filter cycle.

**Custom Filter Cycles:** While you are not required to set filter cycles, if you want to change them, press the “Time” button and the time of day will be shown.

Then press the “\*” button and “set time” will appear on the display. Then press the “\*” button within 3 seconds and “SET START FILTER 1” (AM cycle) will appear on the display.

Press the “Warmer” or “Cooler” button to reset the filter start time.

Next, press the “\*” button and when “SET HEAT” is on the display, press the “Warmer” (on) button to heat the water during filtering, or press the “Cooler” (off) button to disable the heater during filtering.

Press the "\*" to see "STOP FILTER 1" and then adjust the stop time with the "Warmer" or "Cooler" buttons as done above.

Press the "\*" button to see "START FILTER 2" (PM cycle) and proceed as above.

Pressing the "#" button will enter the new filter cycle times into the system and complete the filter programming.

**Ozone Sterilizer (optional):** For safety purposes, your Ozone Sterilizer is disabled for a 30 minute period whenever a "jets" button is pressed.

#### **SAFETY/FEATURE MESSAGES:**

##### **Battery Backup (no message on display)**

When power has been cut off from the spa, the Master Control Pad will use its 30-day battery backup to preserve its settings. When this occurs, the Control Pad will be disabled until power is restored to the spa.

##### **Economy Mode**

The spa is in economy mode. "Econ" is flashed alternately with the current temperature and "COOL" until the spa water is less than 15°F cooler than the set temperature.

##### **Overheat Protection (Spa is Deactivated.)**

**DO NOT ENTER THE WATER.** If a malfunction occurs and the spa water has reached 112°F, the display will flash "OH" (meaning over-heat) and the system will completely shut down. Remove the cover to cool the water. Overheating may also occur if the filter duration is set too long. At 110°F, the spa should reset itself. If the high-limit sensor detects 118°F at the heater, the spa will shut down. When the heater cools to 110°F, press any button to reset the spa. If the spa will not reset, then shut off power to the spa and contact your authorized Bullfrog Spa Dealer.

##### **Flow Switch Detection**

If the panel display is flashing "FLO" (meaning flow) alternately with Temperature, one of the following may have occurred:

- 1- The filter may be plugged. Remove the filter and clean.
- 2- The amount of water flow may be inadequate. Make sure the spa is filled correctly.
- 3- A pressure switch may have malfunctioned. The spa will continue to operate, but the heater will not activate. Contact your authorized Bullfrog Spa Dealer.

##### **Flow Switch Failure**

If the panel display shows a constant "FLO", a pressure

switch has malfunctioned. Contact your authorized Bullfrog Spa Dealer.

### **Temperature Set Back**

When the display shows "COOL", the spa water is more than 20°F cooler than the set temperature. The heater will automatically activate to provide freeze protection. This is a normal spa function; no corrective action is necessary.

### **Freeze Protection**

If a freeze condition is detected "ICE" will be displayed on the panel. The pump(s) will be automatically activated. This is a normal spa function; no corrective action is necessary. Freeze protection is enabled regardless of the spa's status.

### **High-Limit Sensor Failure (Spa is deactivated.)**

When the panel display shows "Sn1" the high-limit temperature sensor is non-functional. This must be repaired only by an authorized Bullfrog Spa Dealer.

### **Main Sensor Failure (Spa is deactivated.)**

If "Sn3" appears on the display, the main sensor is non-functional. This must be repaired only by an authorized Bullfrog Spa Dealer.

### **Standby Mode (Spa is deactivated.)**

When "Stby" appears on the panel display, all spa functions have been disabled except for freeze control. Press any button on the control pad to reset the system. The "Standby Mode" is primarily used to prevent the pumps from being activated while changing JetPaks, cleaning the filter or cleaning the skimmer basket.

### **Warning! Shock Hazard! No User Serviceable Parts.**

Do not attempt service of this control. Contact your authorized Bullfrog Spa Dealer. Follow all Owner's Manual power connection instructions. Installation must be performed by a licensed electrician, and all grounding connections must be properly installed.

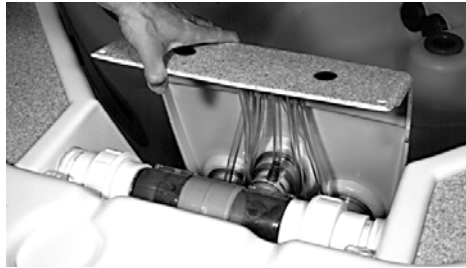

**(Figure N) Removing a JetPak**

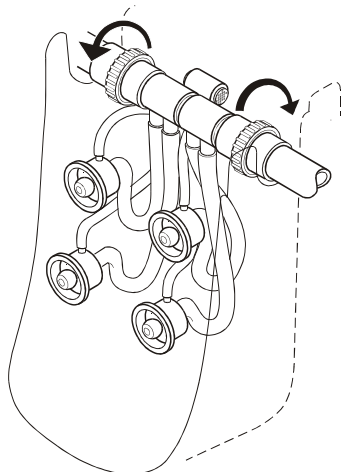

**(Figure O) JetPak Unions**

## JetPaks™

Depending on the model, your Bullfrog Spa is equipped with either one, two, or all three of the following JetPak types:

- Bucket JetPaks
- Recliner JetPaks
- Lounger JetPaks

The difference in these three types of JetPaks is the contour of the backrest. Because the Jet-Pak contours are different, they can only be interchanged with Jet-Paks of their same type (Example: You can interchange a Bucket Seat JetPak with any other Bucket Seat JetPak. but you cannot interchange it with either a Recliner or a Lounger JetPak.

To identify a type of JetPak, locate the JetPak Identification Number found on the back side of the JetPak (example: B2-58). This number provides the following information:

- The Type of JetPak (B=Bucket, R=Recliner, & L=Lounger)
- The Style of JetPak (2=Style Number 2)
- The Water Flow-Rate of the JetPak (58=58 Gallons Per Minute)

### INTERCHANGING JETPAKS:

1. Put the spa in "Standby Mode". This will prevent the pump(s) from activating while interchanging JetPaks. (See "Standby Mode" under "OPERATION" in this Manual.)
2. Remove the headrest.
3. Using your hands, remove the SnapCap (top mounting plate) by lifting it upward.
4. Push the JetPak forward until you have enough room to reach the two PVC unions (Fig. N).
5. Using your hands, loosen the two PVC unions (Fig. O).
6. Pull the manifold out from between the two unions and then remove the JetPak from the JetPod (Fig. N).
7. Exchange the JetPak with another JetPak of the same type.
8. Reattach the JetPaks in the same manner as above.

**Note:** Interchanging JetPaks from one JetZone (see "JetZones" in this manual) to another may result in improper water flows to one or more JetPaks. If you have questions or problems, please consult your authorized Bullfrog Portable Spa Dealer.

**IMPORTANT WARNING:** Spa models with 2 pumps have 2 different jet zones. These JetZones are divided by a JetZone Divider (see "JetZones in this manual). Never operate the spa without the JetZone Divider in place. Doing so, will cause serious damage to your pump(s).

## JETTING:

### JET TYPES (Fig. P)

Depending on the model, your Bullfrog Portable Spa comes with a unique combination of the following jets:

Name	Size
• Ozone Jet	(for ozone system only)
• Cluster Jets	(small)
• Micro Jets	(small-medium)
• Magna Jets	(medium)
• VSR Jets	(medium-large)
• Butterfly-60 Jets	(large)
• Butterfly-92 Jets	(extra large)

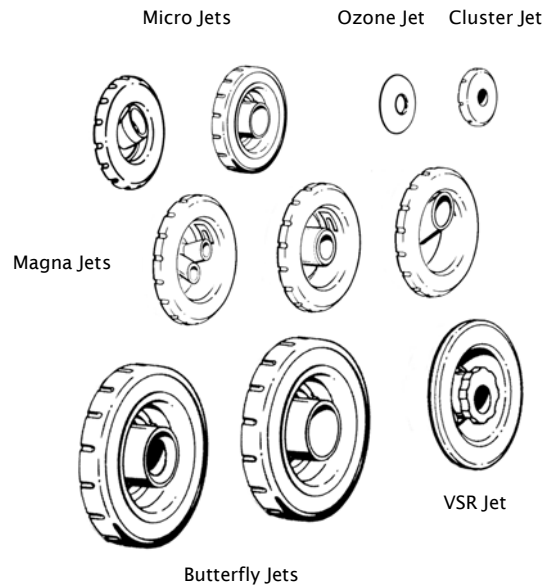

**Figure P**

### INTERCHANGEABLE JETS

The Micro and Magna jets are the only interchangeable jets.

**Micro Jets:** Each Micro Jet comes in either a Directional, or Single-Spinner version, each of which is interchangeable with the other.

**Magna Jets:** Each Magna Jet comes in either a Directional, Single-Spinner, or Dual-Spinner version, all of which are interchangeable with one another.

### ADJUSTABLE JETS (Fig. Q)

To adjust the water pressure on any jet (except VSR Jets), simply turn the outer ring of the jet itself.

**To Increase Jet Water Pressure:** Turn the outer ring of the jet clockwise.

**To Decrease Jet Water Pressure:** Turn the outer ring of the jet counter-clockwise.

**Note 1:** On VSR jets, the speed the jet rotates can be adjusted by simply twisting the center adjusting knob.

**Note 2:** Always contact your authorized Bullfrog Portable Spa Dealer before attempting to add jets or pump horsepower to your spa.

**Note 3:** Never shut all the jets off at the same time.

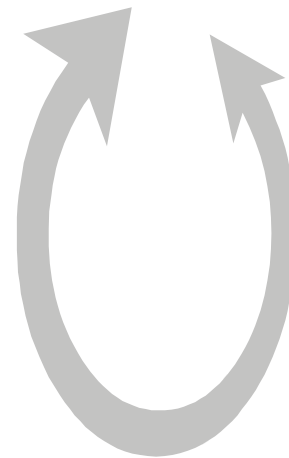

**Figure Q**



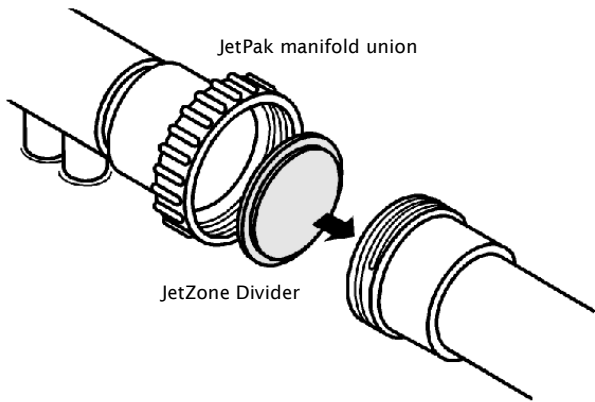

**Figure R**

## JETZONES:

Bullfrog Portable Spas powered by two pumps provide a unique feature called JetZones. A JetZone is a region of jets that are all powered by the same pump. With JetZones, you decide which JetPaks are powered by each pump.

With a two-pump spa you get two JetZones. Each of these JetZones can be customized with the use of a JetZone Divider (Fig. R).

By simply moving the JetZone Divider, you can either increase or decrease the number of JetPaks that are powered by a particular pump, thus creating a new JetZone. By adding JetPaks to a particular JetZone you will decrease the power to that zone. By removing JetPaks from a particular zone you will increase the power to that zone.

## TO CREATE A NEW JETZONE:

1. Put the spa in "Standby Mode". This will prevent the pump(s) from activating while disconnecting JetPaks. (See "Standby Mode" under "OPERATION" in this Manual.)
2. Locate the JetPak that contains the JetZone Divider.
3. Remove the headrest.
4. Using your hands, remove the JetPak top mounting plate by lifting it upward.
5. Push the JetPak forward until you have enough room to reach the two PVC unions.
6. Using your hands, loosen the two PVC unions.
7. Pull the manifold out from between the two unions and then remove the JetPak from the JetPod.
8. Remove the JetZone Divider (Fig. R) and reattach the JetPak in the same manner as you removed it.
9. Install the JetZone Divider in a location of your choice.

**Note:** If you would like to interchange JetPaks, please refer to "JetPaks" in this Manual.

**IMPORTANT WARNING:** Never operate the spa without the JetZone Divider in place. Doing so, will cause serious damage to your pump(s).

# MAINTENANCE

## WATER CHEMISTRY

Tap water that is safe to drink is not always right for your spa. Normal tap water is usually filled with minerals and micro-contaminants that are not visible to the naked eye.

Properly testing and treating your spa water is essential for the health of your spa as well as the people that use it.

Proper chemical maintenance can control and help prevent the following: 1. Bacteria, algae and fungi, which can spread disease and infection to humans; and, 2. Staining and scale build-up on your spa shell, equipment, and piping; and, 3. Clogged filters.

***Note 1:** When using chemicals, always follow the instructions provided on the manufacturer's labels.*

***Note 2:** Use an accurate test kit to perform all chemistry tests.*

***Note 3:** Never mix chemicals.*

***Note 4:** With the exception of Chlorine or Bromine Tablets, always add chemicals directly to the spa, evenly spreading the chemicals over the surface of the water. Run the Filter Pump at high-speed for 15 or more minutes after applying any chemical.*

### OVERVIEW OF WATER CHEMISTRY:

**1. Sanitation:** Sanitizers kill bacteria and keep the water clean. Effective and safe sanitizers include any of the following: GRANULAR CHLORINE (Dichlor), GRANULAR BROMINE, CHLORINE TABLETS (TriChlor) OR BROMINE TABLETS.

***Note:** Non-trichlor chlorine tablets and/or non-dichlor granular chlorines must not be used in your spa, they may damage the spa, voiding your warranty.*

**2. Super-Sanitation:** As your spa is used, non-filterable wastes, including perspiration, oils, hair sprays, etc, will build up in the spa water. These substances make the water unattractive in appearance and odor, and can also interfere with sanitizer effectiveness. Normal sanitation does not eliminate these waste substances, but Super-Sanitation does. Super-Sanitation is achieved by "shocking" the spa water with a NON-CHLORINE SHOCK (Potassium Peroxymonosulfate), GRANULAR CHLORINE (Dichlor) or GRANULAR BROMINE.

***Note:** Non-Chlorine Shock is the preferred shocking chemical because it will shock the water without raising the sanitizer level.*

**3. pH Control:** Proper pH balance is extremely important in controlling bacteria, providing water that's comfortable for the user, and in preventing damage to the spa and its equipment. Using the scale

of 0-14, pH is the measure of acidity and basicity in the water. pH levels under 7.0 are acidic while pH levels over 7.0 are basic. The proper pH range for a spa is 7.4 to 7.6.

**High pH levels (over 7.6) can cause the following:** Scale build-up on the spa and its equipment, cloudy water, a prematurely dirty filter, and less effective chlorine sanitation. To correct high pH levels, add a pH DECREASER.

**Low pH levels (under 7.4) can cause the following:** Discomfort to the spa user and corrosion to the spa and its equipment. To correct low pH levels, add a pH INCREASER.

*Note: Never use muriatic or hydrochloric acid to adjust pH as it can damage your spa shell and surroundings.*

**4. Total Alkalinity (TA):** Total Alkalinity (TA) is the measure of carbonates and bicarbonates in the water. Low TA can cause pH to be unstable, bouncing from one level to another, causing the water to be corrosive or scale forming to the spa and its equipment. To correct low TA, add a TOTAL ALKALINITY INCREASER. High TA can cause scale build-up, cloudy water, as well as other pH problems. To correct high TA, contact your authorized Bullfrog Portable Spa Dealer.

**5. Calcium Hardness (CH):** Calcium Hardness (CH) is the measure of dissolved calcium in the water. Low CH (soft water) can result in staining to the spa's surface as well as corrosion to the spa and its equipment. To correct low CH, add a CALCIUM HARDNESS INCREASER. High CH (hard water) can cause cloudy water as well as rough scale build-up on the spa's surface and equipment. To correct or manage high CH, contact your authorized Bullfrog Portable Spa Dealer.

**6. Stain & Scale Control:** Stain and scale problems are common in hot water environments. To help prevent and control staining and scaling, add a STAIN & SCALE INHIBITOR.

**7. Foam Control:** Spa water that's polluted with body oils and lotions, combined with high water temperatures, can cause excessive surface foaming. To prevent and control foam on the surface of the spa water, add a FOAM REMOVER.

**8. Clearing Cloudy Water:** There are two basic reasons that spa water becomes cloudy. First, non-filterable liquid wastes (perspiration, etc.) have contaminated the water. To remove these waste substances, Super-Sanitize the water (as described above). Second, non-filterable micro-particulate wastes (dust, etc.) have contaminated the water. To remove these wastes substances, use a WATER CLARIFIER.

*Note: Names of spa chemicals will vary from one manufacturer to another. Please consult your authorized Bullfrog Portable Spa Dealer if you have questions.*

## STARTING YOUR SPA WITH NEW WATER:

1. As your spa fills with tap water, add the prescribed dose of a STAIN & SCALE INHIBITOR. This will provide the initial protection against staining and scaling.

**Note:** *Do not use soft water unless the mineral content is raised immediately.*

2. When your spa is completely filled with water, add the prescribed dose of a WATER CLARIFIER. This will clear the water of any micro-particulates that came with the new water.

3. If possible, have your authorized Bullfrog Spa Dealer test the Calcium Hardness (CH) of your spa water and adjust as per your dealer's recommendation (the correct level of CH depends on your overall water conditions).

4. Test and adjust the Total Alkalinity (TA) to the range of 125-150 PPM (parts per million).

5. Test and adjust the pH to the range of 7.4-7.6.

6. After the spa water has circulated for approximately one hour, add 1/2 teaspoon of GRANULAR CHLORINE or 1 teaspoon of GRANULAR BROMINE per each 200 gallons of spa water. After several hours, check sanitizer level and, if necessary, adjust to the following:

	Without Ozone	With Ozone
Chlorine Level:	2.0 PPM	1.0 PPM
Bromine Level:	3.0 PPM	2.0 PPM

**Important:** Unless you have ozone, do not use the spa if the sanitizer level is below 1.0.

Start-up water chemistry is now complete. However, it may take several days for the filter to completely clear the water.

## MAINTAINING SPA WATER

### Sanitizer and pH Levels:

It is important to test and adjust the sanitizer and pH levels of your spa on a frequent basis. If your spa is used 0-3 times weekly, then we recommend that you test your spa water a minimum of 2-3 times that week. For each additional use you should test your spa water one additional time.

Always test the pH level before you test the sanitizer level. If the pH level is not in the range of 7.4-7.6, then make the necessary adjustment. Use the dosage prescribed on the label.

With each sanitizer test, use either GRANULAR BROMINE or GRANULAR CHLORINE to maintain the following levels:

	Without Ozone	With Ozone
Chlorine Level:	2.0 PPM	1.0 PPM
Bromine Level:	3.0 PPM	2.0 PPM



**(Figure S) Accessing the Tablet Feeder**

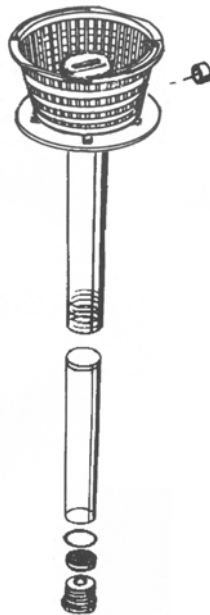

**(Figure T) Tablet Feeder Assembly**

To maintain the above sanitizer level with CHLORINE or BROMINE TABLETS, read the following section.

**TABLET FEEDER - Chlorine/Bromine (optional):**

The Feeder is located in the filter/skimmer area of your spa (Fig. S). It is attached to the filter basket. It's function is to assist you in maintaining the proper chlorine/bromine level when using tablets.

**Warning:** Never mix chemicals or use any other chemical in the Tablet Feeder other than CHLORINE or BROMINE TABLETS. Doing so, may cause an explosion or fire. If GRANULAR BROMINE or GRANULAR CHLORINE is used to Super-Sanitize your spa water, then turn off the Tablet Feeder until all granules have dissolved. Failure to do so may result in granules entering the Tablet Feeder causing an explosion or fire. The Tablet Feeder does not need to be turned off when using a NON-CHLORINE SHOCK to Super-Sanitize your spa water.

Before using the Tablet Feeder, it is recommended that you adjust the sanitizer level to between 1.0-1.5 PPM by using either GRANULAR BROMINE or GRANULAR CHLORINE. If this step is not taken, it may take several days for the "slow-dissolving" CHLORINE or BROMINE TABLETS to achieve the proper sanitizer level.

**To use the Tablet Feeder:** (Fig. T)

1. Put the spa in "Standby Mode". This will prevent the pump from activating while accessing the Tablet Feeder. (See "Standby Mode" under "OPERATION".)
2. Remove basket assembly with attached Tablet Feeder. Turn counter clockwise and carefully align flats. If aligned properly, unit should easily lift out in one piece. DO NOT FORCE.
3. Remove check-valve assembly by turning counter clockwise.
4. Fill the Tablet Feeder with 1" CHLORINE or BROMINE TABLETS. If the tablets are too large, it is OK to split the tablets so they will fit into the Tablet Feeder's chamber.
5. Make sure o-ring is clean and lubricated with a silicone lubricant (Never use oils or greases).
6. Screw on check-valve assembly. Do not overtighten.
7. Reinsert basket assembly and turn clockwise to lock into position.
8. Adjust the Dial Control Valve, located at the top of the feeder, to an output level that will produce the proper chlorine or bromine level (see Sanitizers and pH Levels). Turn the dial clockwise for more bromine and counter-clockwise for less chlorine/bromine. The demand for chlorine/bromine may change from one day to the next. Check your chlorine/bromine level and adjust the Tablet Feeder on a regular basis. It may take several days of

adjusting the Tablet Feeder to determine the output level that you will most commonly use. Making small, gradual adjustments is the easiest way to find the ideal setting.

*Note: If your spa is small in size and/or your usage is very light, you may notice that the Tablet Feeder dispenses too much chlorine/bromine into the water, even when you have adjusted the Dial Control Valve to its lowest setting. If you experience this, contact your authorized Bullfrog Portable Dealer for a free "Inner Chamber". The Inner Chamber reduces the volume of Chlorine/Bromine allowed to enter the spa, giving you finer adjustment control.*

**Super-Sanitation:**

Once per week, and when the spa is not in use, Super-Sanitize the spa water by adding one of the following:

- Two teaspoons of GRANULAR CHLORINE per 200 gallons of spa water.
- Four teaspoons of GRANULAR BROMINE per 200 gallons of spa water.
- Five teaspoons of a NON-CHLORINE SHOCK per 200 gallons of spa water.

*Note 1: With above-average use, Super-Sanitation may be required more than once per week.*

*Note 2: With ozone, it may not be necessary to shock on a weekly basis (see your dealer).*

**Stain & Scale Control:** Use a STAIN & SCALE INHIBITOR as per the instructions on the manufacturer's label. Do not add this chemical until 3-4 days after Super-Sanitation.

**Foam Control:** As needed, use a FOAM REMOVER as per the instructions on the manufacturer's label.

**Cloudy Water Prevention & Control:** Use a WATER CLARIFIER as per the instructions on the manufacturer's label. Do not add this chemical until 3-4 days after Super-Sanitation.

**WATER CHEMISTRY TROUBLESHOOTING**

Prior to each spa use, check the spa water. If the water appears cloudy or off-color, has significant surface foam or smells of chlorine/bromine, then there is a problem with the water and it needs to be treated or drained. Using the spa in these conditions could result in a skin rash or other irritation.

For assistance in handling spa water chemistry problems, consult your authorized Bullfrog Portable Spa Dealer or another service center capable of performing a Computerized Water Analysis.

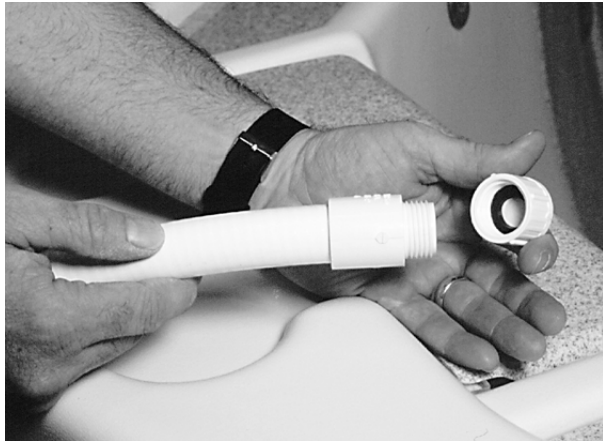

**(Figure U) Drain Cap**

## CHANGING YOUR SPA WATER

Depending on usage, your spa water will need to be changed approximately every 2-4 months or whenever your spa water becomes difficult to manage.

### Steps to Drain Your Spa:

1. Disconnect electrical power supply.
2. Remove door to Equipment Compartment.
3. Drain water from spa by completing the following:
  - a. Locate Drain Hose in Equipment Compartment.
  - b. Lift Drain Hose higher than water level in spa.
  - c. Remove cap on Drain Hose (Fig. U).
  - d. Connect garden hose to Drain Hose.
  - e. Lower Drain Hose to ground level.

**Note 1:** Drain water to an area that can handle the gallonage of your spa.

**Note 2:** If draining water onto vegetation, make sure that the sanitizer level (bromine or chlorine level) of your spa water is less than .5 PPM.

4. Clean the spa shell (refer to "Spa Shell Care" in this Owner's Manual).

### Steps To Refill Your Spa:

1. Remove garden hose from Drain Hose and replace Drain Hose Cap.
2. Reattach door to Equipment Compartment.
3. Refill spa with tap water. Fill the spa to any point between the two Water Level Indentation marks located on the back wall of the filter/skimmer cavity. The depth range of these marks is 6-7½" down from top of spa.

**Note 1:** The higher the water level, the fewer spa users it will take to cause the water to overflow the top of the spa.

**Note 2:** Do not fill your spa with soft water unless the mineral content is raised immediately.

4. Restore electrical power supply.
5. See "Starting Your Spa with New Water" under "Water Chemistry" in this Owner's Manual.

## CLEANING YOUR FILTER

### Cleaning the Filter Basket:

1. Put the spa in "Standby Mode". This will prevent the pump from activating while cleaning the basket. (See "Standby Mode" under "OPERATION" in this Owner's Manual.)
2. Remove skimmer and attached basket (Fig.V). Turn counter clockwise and carefully align flats. If aligned properly, unit should easily lift out in one piece. DO NOT FORCE.
3. Separate basket from skimmer basket adapter by spreading boss on basket away from adapter wall (Fig. W).
4. Clean the basket. Avoid hitting basket against objects to knock debris loose as this can break basket.
5. Reattach basket to skimmer adapter. Slip notch of basket adapter under boss of basket on one side. Snap other side into place. (See illustration)
6. Reinsert skimmer with basket and turn clockwise to lock into position .
7. Press any button on the control pad to reset the control system.

### Cleaning the Filter Cartridge:

It is recommended that your Filter Cartridge be cleaned every 3 to 6 weeks or as needed. Replace the Filter Cartridge approximately every two years or when necessary. To maintain warranty protection, use only Bullfrog Filter Cartridge replacements.

1. Put the spa in "Standby Mode". This will prevent the pump from activating while cleaning the cartridge. (See "Standby Mode" under "OPERATION" in this Owner's Manual.)
2. Remove skimmer and basket.
3. Grasp cartridge and lift out. With a garden hose and nozzle or other high pressure device, hose cartridge clean with jet stream of water. Work top to bottom on each pleat. To remove collected suntan lotions and body oils that hosing will not remove; soak cartridge in warm water with a FILTER CLEANER or detergent added. To remove calcium deposits (a white chalky material) soak cartridge in a one part muriatic acid to ten parts water solution. USE A PLASTIC CONTAINER ONLY. Calcium deposits indicate a high spa pH, which should be corrected.
5. CAUTION: Using a brush to clean cartridge could damage it. Commercially available cartridge cleaners may be used and can be obtained from your authorized Bullfrog Portable Spa Dealer.
6. Reinstall cartridge, basket and skimmer.
7. Press any button on the control pad to reset the control system.



(Figure V) Skimmer, Basket & Filter Location

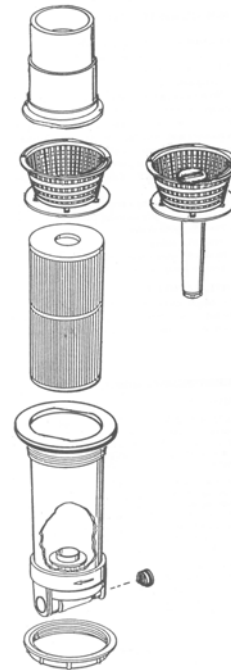

(Figure W) Skimmer, Basket & Filter





(Figure X) Light Bulb Location

## LIGHT BULB REPLACEMENT

To replace a burned out or defective light bulb, complete the following steps:

1. Disconnect electrical power supply.
2. Remove the door to the Equipment Compartment.
3. Locate the back of the Spa Light Fixture (Fig. X).
4. Grasp the light bulb holder located on the back of the Spa Light Fixture. Twist counter-clockwise to release it from Spa Light Fixture. Pull light bulb holder out of Spa Light Fixture.
5. Replace light bulb and reinstall light bulb holder into Spa Light Fixture.
6. Replace door to Equipment Compartment.
7. Restore electrical power supply.

## OZONE STERILIZER REPLACEMENT

On the front of your Bullfrog Ozone Sterilizer (optional) is an ozone indicator light (the Ozone Sterilizer is located in the equipment compartment). This indicator light will glow whenever ozone is being produced.

To verify that your Ozone Sterilizer is working properly, check the indicator light when the filter pump is running and only during a preprogrammed filter cycle, making sure that the indicator light glows (do not check the indicator light if you have activated the jets within the previous 30 minutes - as a safety device, your Ozone Sterilizer shuts down for 30 minutes after the "Jets" button has been pressed).

If the indicator light does not glow when the filter pump is running then your Sterilizer is not working properly. When this occurs, take the following steps:

1. Disconnect electrical power supply.
2. Locate the Ozone Sterilizer (Fig. Y).
3. Unplug the Ozone Sterilizer's power supply cord from your spa's Control Center.
4. Disconnect the grounding wire from the Ozone Sterilizer.
5. Disconnect the output tubing from the Ozone Sterilizer.
6. Remove the mounting screws that hold the Ozone Sterilizer in place.
7. Take the entire Ozone Sterilizer to your authorized Bullfrog Portable Spa Dealer. Your Ozone Sterilizer will be checked to verify that it is defective. If defective, then replace the entire Ozone Sterilizer with a new one.

**Note:** If your Ozone Sterilizer is found to be working properly, then you may have a problem with your spa's Control Center or Control Pad. Consult your dealer and request a service call.

8. Reinstall the Ozone Sterilizer by reversing the above procedure.

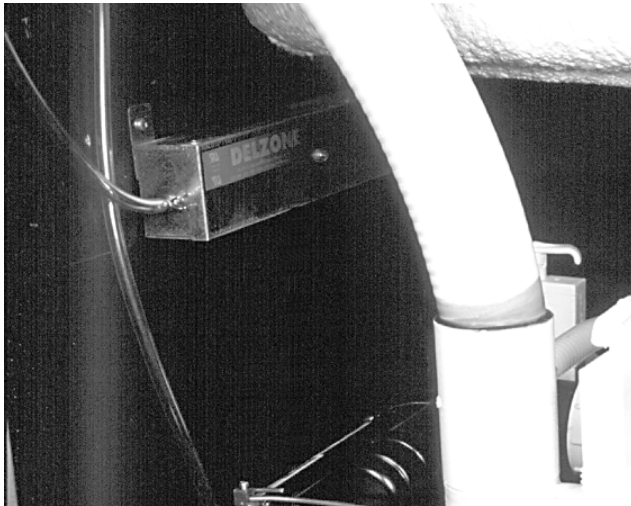

(Figure Y) Ozone Sterilizer Location

## SPA SHELL CARE

Your Quarite Plus® spa surface is durable and easy to clean:

For normal cleaning, use Ivory® Liquid dishwashing detergent or its equivalent. For stubborn stains, use Spic & Span® in powder form or its equivalent. To apply these cleaners, use a soft, damp cloth or sponge. Rinse well and dry with a clean cloth.

With normal use of your spa, oils, lotions and hairsprays will build up on the surface of the water, sometimes leaving a scum line around the perimeter of your spa shell. This scum line can easily be removed with a spa SURFACE CLEANER or its equivalent.

To remove grease, oil, paint and ink stains, use isopropyl (rubbing) alcohol.

For hard water stains consult your authorized Bullfrog Portable Spa Dealer for acceptable cleaning agents.

To remove light scratches and/or to protect your spa's shell, see your Bullfrog Dealer for an acceptable spa wax.

**Note 1:** *Never allow your spa surface to come in contact with acetone (nail polish remover), nail polish, dry cleaning solution, lacquer thinners, gasoline, pine oil, abrasive cleaners, or any other harsh chemical. These chemicals can damage your spa shell and void your warranty.*

**Note 2:** *Avoid using cleaning agents that will leave suds in your spa water.*

**Note 3:** *Be sure to clean the JetPaks and the JetPods (the area behind the JetPaks) approximately twice each year.*

## SPA CABINET CARE

**Cedar Wood Cabinet:** Depending on exposure to sunlight, water, and spa chemicals, your spa cabinet will require staining every 3-9 months. Use an oil-based stain that absorbs into the wood. See your authorized Bullfrog Portable Spa Dealer for the right stain.

**Note 1:** *Avoid sealers that cover only the outside of the wood, causing the inside to dry out and crack or even warp.*

**Note 2:** *To prevent stain from getting on other surfaces, use drop cloths at the base of the spa and use painter's tap around the top lip of the spa.*

## SPA COVER CARE

Your spa cover is warranted by its manufacturer, Sunstar Enterprises, 127 N. Las Posas, San Marcos, CA 92069 (Phone 619-744-2172). Although basic instructions are provided below, it is important that you refer to the Sunstar information that came with

your cover. Sunstar provides detailed information on caring for your spa cover and what to do to protect its warranty.

### **Cleaning & Conditioning Your Spa Cover:**

#### **On a monthly basis, complete the following:**

1. Remove the spa cover and lay it down on a flat, clean surface near a garden hose.
2. Rinse the cover to remove any loose debris.
3. Using a soft bristle brush, clean the top (vinyl portion) of the cover with a mild solution of dishwashing liquid soap-about one teaspoon of soap to two gallons of water. Scrub the cover, using a gentle circular motion, being careful not to let any areas of the cover dry before rinsing with water.
4. Rinse the cover thoroughly and then dry with a clean cloth.
5. Use saddle soap (never use Armorall) to condition the cover. Follow directions on the container.
6. Wipe and/or rinse any dirt from the bottom side of the cover.
7. Replace the cover and secure with cover locks.

***Note:** To remove tree sap, use lighter fluid (not charcoal lighter, but the type used in cigarette lighters). Use sparingly. Immediately apply saddle soap to that area.*

## **MISCELLANEOUS CARE**

**Cleaning & Protecting the Headrests:** Clean on a regular basis with soap, water and a clean cloth. Use Armorall® Protectant or its equivalent once per month. This will maintain water resistance and luster of the product.

**Vacuuming the Spa:** Debris from wind, trees, and spa users will occasionally accumulate on the bottom of your spa. Your spa's filtration system will remove the smaller debris. Debris that is too large or too heavy for the filtration system will have to be removed by the use of a spa vacuum. If you do not have a spa vacuum, please contact your authorized Bullfrog Portable Spa Dealer.

**Cleaning the Scum Line:** With normal use of your spa, oils, lotions and hairsprays will build up on the surface of the water, sometimes leaving a scum line around the perimeter of your spa shell. This scum line can easily be removed with a spa SURFACE CLEANER or its equivalent. See your authorized Bullfrog Portable Spa Dealer for this product.

***Note:** Avoid using cleaning agents that will leave suds in your spa water.*

## LOW-USE OR NO-USE PERIODS

At certain times of the year you may not use your spa as often as expected. For these low-use or no-use periods, we recommend the following:

**Low-Use:** If your spa is being used less than once per month, then you may wish to lower the temperature setting by approximately 5-10°F or put the spa in the "Economy Mode". Lowering the temperature on your spa will cut your cost of operation if you are not using the spa for extended periods, however, you will need to adjust the temperature setting approximately 15 minutes before each use to heat the spa to the desired level.

**No Use for 1-2 Weeks:** If you plan to not use your spa for one-two weeks, then we suggest that you not make any changes in operating your spa. Substantially reducing the water temperature (in well insulated spas) for short periods of time has proven to increase heating costs.

**No Use for 2-6 Weeks:** If you plan to not use your spa for two-six weeks, then you may wish to lower the temperature setting to approximately 80°F during the No-Use period.

**No Use for Over 6 Weeks:** If you plan to not use your spa for over six weeks, then it is suggested that you winterize your spa by taking the following steps:

### SPA WINTERIZATION:

1. Drain the water from the spa (see "Steps to Drain Your Spa" under "Changing Your Spa Water" in this Owner's Manual).
2. Drain the spa equipment. This is done by removing the drain plug from the pump(s) and loosening all PVC pipe unions in the equipment compartment.
3. Clean the spa shell (see "Spa Shell Care" in this Owner's Manual).
4. Remove filter cartridge, clean filter (see "Cleaning Your Filter" in this Owner's Manual), allow filter to dry, and then store filter inside your garage or home.
5. Reattach and secure cover to the spa.

### SPA DE-WINTERIZATION:

De-Winterization is completed by reversing the above procedure and then refilling the spa (see "Steps to Refill Your Spa" under "Changing Your Spa Water" in this Owner's Manual).

**Note:** *During periods of No-Use, you should test and chemically treat the water approximately once per week. Not doing so may lead to corrosion, staining and/or scaling to your spa and its equipment. If there is no one available to take care of the spa on a weekly basis, then it is recommended that you winterize your spa as described above.*

## SERVICE

Before requesting service from your dealer, refer to the Trouble Shooting Guide in this Owner's Manual to determine the necessary course of action. If you are not able to solve the problem using the Trouble Shooting Guide, please contact your authorized Bullfrog Portable Spa Dealer.

## WARRANTY SERVICE

If your Bullfrog Portable Spa fails within the warranty period and within the scope of its warranty, contact your authorized dealer and schedule a service call. You will be required to show proof of purchase by provided your dealer with a copy of your original sales receipt.

*Note : Damage caused by repairs made by someone other than an authorized Bullfrog Portable Spa technician will not be covered by your warranty.*

## NON-WARRANTY SERVICE

We recommend having an authorized Bullfrog Portable Spa technician perform all repairs on spas that fail outside of warranty coverage or beyond the warranty period. If you are not able to use an authorized Bullfrog Spa technician, we encourage you to request and use genuine Bullfrog replacement parts.

If you are not able to obtain service in your area, call Bullfrog International, L.C. at:

**801-565-8111**

## Purchase Information

-----  
YOUR SPA'S SERIAL NUMBER

-----  
DATE YOU PURCHASED YOUR SPA

## Dealer Information

-----  
Dealer Name

-----  
Street Address

-----  
City, State, & Zip Code

-----  
Phone Number

## TROUBLESHOOTING GUIDE

The following guide was prepared to assist you in solving simple problems with your spa. If the problem with your spa cannot be solved after following these procedures, please contact your authorized Bullfrog Portable Spa Dealer.

**PROBLEM: Control Panel displays one of the following messages:**

"ECON", "OH", "FLO", "COOL", "ICE", "Sn1" or "Sn3".

**Cause:** For causes and solutions, see "Safety/Feature Messages" under "OPERATION" in this Owner's Manual.

**PROBLEM: Control Pad and spa equipment do not operate.**

**Cause: 1.** No electrical power to spa.

**Solution:**

- A. Reset or turn on the GFCI circuit breaker.
- B. Have a qualified electrician check your electrical service.

**Cause: 2.** The 30-Amp fuse in the Control System has blown.

**Solution:** Contact your authorized Bullfrog Portable Spa Dealer.

**PROBLEM: Spa pump turns off during operation.**

**Cause: 1.** Automatic timer has completed its 30 or 120 minute cycle.

**Solution:** Turn on the pump at the Control Pad.

**Cause: 2.** Pump has overheated due to vents in equipment door being blocked.

**Solution:** Clear items away from vents in equipment door.

**Cause: 3.** The pump motor is defective.

**Solution:** Contact your authorized Bullfrog Portable Spa Dealer.

**PROBLEM: Spa will not heat.**

**Cause: 1.** Spa filter cartridge is dirty.

**Solution:** See "Cleaning Your Filter" in this Owner's Manual.

**Cause: 2.** Thermostat on Control Pad has been turned down.

**Solution:** Adjust thermostat to desired temperature setting.

**Cause: 3.** High Limit sensor has tripped.

**Solution:** Touch any button on the Control Pad to reset High Limit.

**Cause: 4.** Heating System is defective.

**Solution:** Contact your authorized Bullfrog Portable Spa Dealer.

**PROBLEM: Spa Light does not work.**

**Cause: 1.** Light bulb has burned out.

**Solution:** See "Light Bulb Replacement" in this Owner's Manual.

**Cause: 2.** Lighting System is defective.

**Solution:** Contact your authorized Bullfrog Portable Spa Dealer.

**PROBLEM: Spa pump will not turn on, creates burning smell when running, or makes excessive noise when running.**

**Cause:** Pump motor is defective.

**Solution:** Contact your authorized Bullfrog Portable Spa Dealer.

**PROBLEM: Jets surge on and off.**

**Cause:** Water level in spa is too low.

**Solution:** Adjust water level to any point between the two water level indentation marks on the back wall of the filter/skimmer cavity.

**PROBLEM: Jets are weaker than normal or do not work at all, but in both cases the pump is running.**

**Cause: 1.** Spa filter cartridge is dirty.

**Solution:** See "Cleaning Your Filter" in this Owner's Manual.

**Cause: 2.** There is air trapped in the spa equipment or its face piping.

**Solution:** Loosen PVC pipe unions in equipment compartment and allow air to bleed out of system. Be sure to tighten each PVC union as soon as water starts to bleed out.

**Cause: 3.** The Suction Fitting(s) are blocked.

**Solution:** Remove any item or debris that is blocking each Suction Fitting.

**Cause: 4.** The JetZone Divider is not installed (This only applies to spas that have two pumps).

**Solution:** Re-install in the appropriate JetPak position. (Warning: Running your spa without a JetZone Divider can cause serious damage to your pump.)

# PARTS IDENTIFICATION

## Inside Equipment Compartment

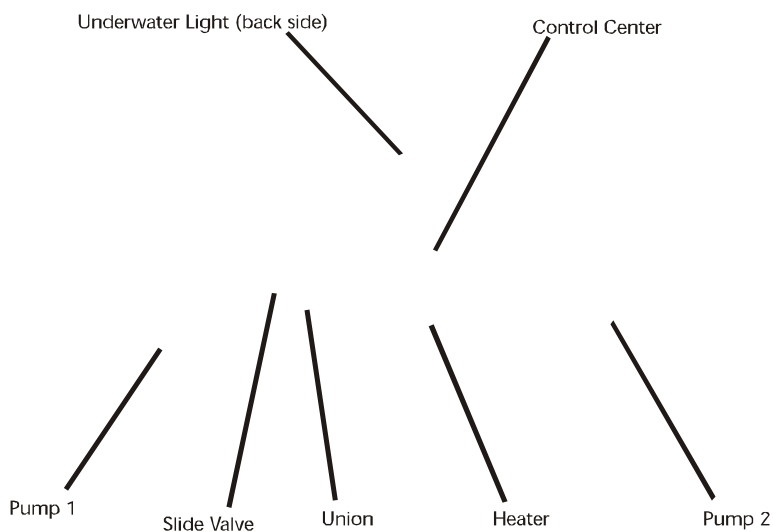

## Top View of Spa (662 Model Shown)

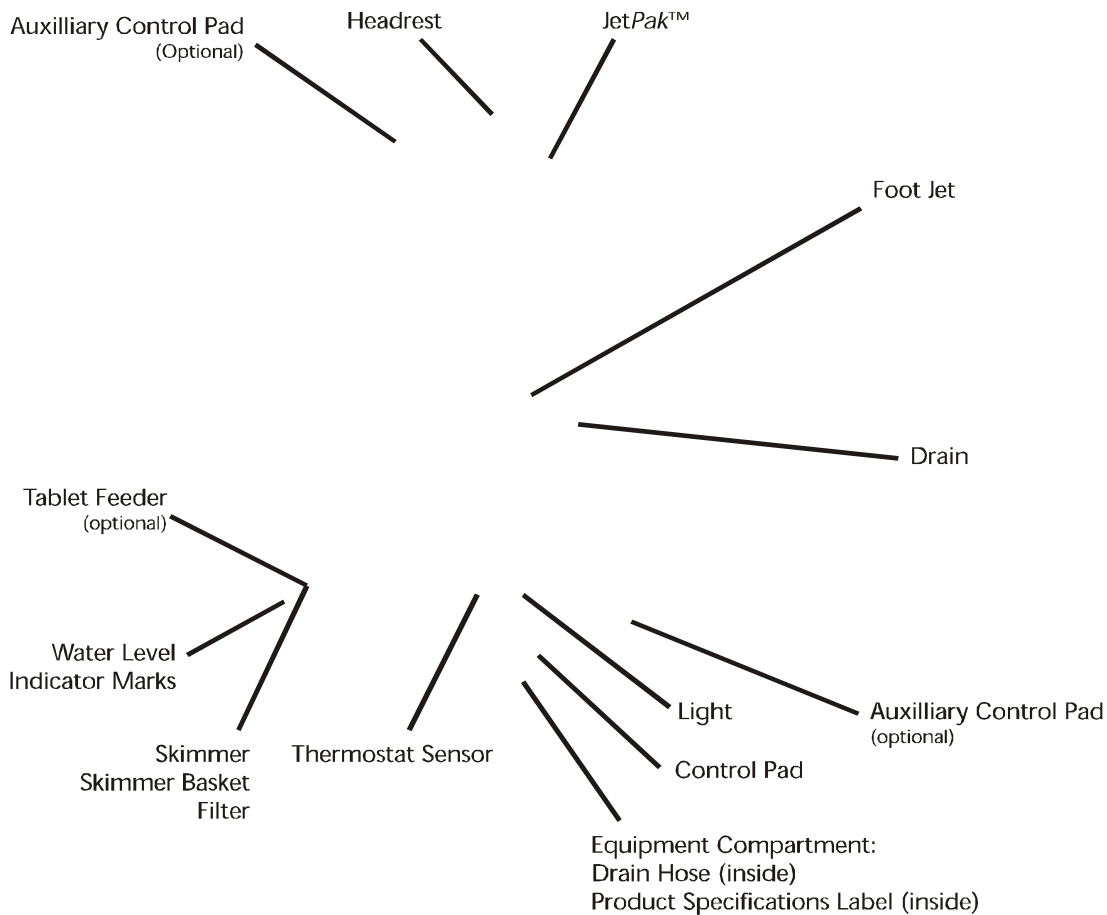



**NOTES:**



*The Adaptable Spa™*

**Bullfrog International, L.C.**

9479 South 500 West · Sandy, Utah 84070

801 565-8111 · Fax 801 565-8333

*[www.bullfrogspas.com](http://www.bullfrogspas.com)*